

**Ziegler
&Brown**

PORTABLE GRILL THE TAKE ANYWHERE BBQ

OPERATING INSTRUCTIONS



Barbeque stand sold separately

Covering Models ZG1GK / ZG1NGK / ZG1GRK /

Congratulations on Your Purchase and Welcome to the World of Outdoor Cooking

IMPORTANT HEALTH & SAFETY INFORMATION:

Australia has an excellent safety record when it comes to gas appliances. This reflects both the high quality of appliances sold, as well as growing consumer awareness about safe practice. We urge you to follow these guidelines and instructions for safe use, to prevent overheating and to produce great cooking results.

- Please read these instructions carefully prior to assembly and use. Failure to follow these instructions could lead to serious injury and/or significant damage to property.
- This barbeque is an outdoor appliance only. Under no circumstances should it be used indoors.
- Do not start the barbeque if there is any doubt over the correct assembly, ignition, gas control or safe operation of the unit.
- These instructions should be retained for future reference.
- This barbeque has not been approved for marine use.
- Never attempt to ignite the barbeque with the hood or the grease cup closed.
- Do not perform any servicing on the barbeque yourself. This includes internal adjustment of the regulator and gas valves. Servicing can only be carried out by authorised technicians.
- It is important that you install your barbeque exactly as described in these instructions. In particular you should keep the barbeque clear of combustible material, and you should check for leaks whenever a new connection is made.
- Do not store chemicals or flammable materials near this appliance.
- Do not place articles on, against, or enclose this appliance.
- The barbeque gets extremely hot while in use. Keep children away from the appliance until it has cooled to normal temperatures.
- It is a good idea to tie back long hair and loose clothing while cooking in case of unexpected flare ups.
- Fat fires are the most common cause of problems in barbeques. They are caused by a build up of grease in the grease cup and the inside of the barbeque frame. A fat fire can be difficult to put out, and will be dangerous if it spreads to the gas hose. You should keep your barbeque clean to avoid this occurrence. Fat fires will void the warranty.
- Do not attempt to move or transport the barbeque whilst it is hot. Always allow the barbeque to completely cool down before moving or covering.

- NEVER leave the barbeque unattended with the burner switched on. Always switch **OFF** the burner and cylinder or gas supply valves when the barbeque is not in use.
- Take care when touching a hot barbeque, especially on surfaces close to the firebox or roasting hood.
- It's fine to pre-heat with the burner on **HIGH** and the hood closed, but NEVER let the temperature on the hood thermometer exceed 300 degrees Celsius.
- When cooking with the hood closed, turn the burner to **LOW** or **OFF** as required to keep the barbeque from getting too hot. NEVER let the temperature on the hood thermometer exceed 300 degrees Celsius.
- NEVER leave the burner on **HIGH** for more than 15 minutes without checking, always stay in control by adjusting the burner to **LOW** and **OFF** as required to maintain suitable cooking temperatures.
- Follow all manufacturer's instructions to periodically check for gas leaks.
- Flammable materials and liquids must be stored well away from the barbeque.
- Aerosols must not be used near a lit barbeque.
- Gas bottles **MUST** be transported stored and used vertically only.
- Avoid dousing the barbeque with water.
- For safety reasons it is advisable to keep a fire extinguisher and fire blanket close to hand.
- Unsupervised children and the infirm should not be allowed too close to the barbeque during pre-heat, cooking, burn off or cooling down of the unit.
- Please dispose of all polythene packing and plastic bags carefully and keep out of the reach of children.
- Spare or extra gas bottles must **NOT** be stored within close proximity of this barbeque or any other gas or electric appliance.
- Spare or extra gas bottles should **NOT** be stored where they are exposed to continuous direct sunlight, as this is a potentially dangerous practice.
- The position of the assembled barbeque should be such that the gas bottle is not left exposed to continuous direct sunlight as this is a potentially dangerous situation.
- For storage and gas cylinder exchange, disconnect the gas cylinder only. **DO NOT** disconnect the hose and regulator from the barbeque.

Where to Put Your Barbeque When it is in Use

- Please make sure that the barbeque is NOT positioned underneath any combustible material or surface.
- There MUST be a clearance of at least 250mm from the sides and the back of the barbeque to any combustible materials or surfaces. There must also be a clearance of at least 1500mm above the cooking surfaces to any combustible surface.
- Flammable materials of any description MUST be kept well away from the barbeque.
- The barbeque must be positioned such that the gas bottle is kept away from continuous direct sunlight.
- The barbeque must be positioned to avoid walkways, gangways and general pedestrian access.
- The nature of a barbeque is such that many of the surfaces are hot to touch, the positioning of the barbeque should take into consideration the possibility of accidental hand or body contact.

Putting your Barbeque in an Enclosure

This appliance must only be used in an above ground, open air situation with natural ventilation, without stagnant areas, where gas leakage and products of combustion are rapidly dispersed by wind and natural convection. **Any enclosure in which the appliance is used must comply with one of the following:**

- An enclosure with walls on all sides, but at least one permanent opening at ground level and no overhead cover. SEE EXAMPLE 1
- Within a partial enclosure that includes an overhead cover and no more than two walls.
- SEE EXAMPLE 2 & 3
- Within a partial enclosure that includes an overhead cover and more than two walls, the following shall both apply: (1) At least 25% of the total wall area is completely open and (2) at least 30% of the remaining wall area is open and unrestricted SEE EXAMPLE 4 & 5
- In the case of balconies, at least 20% of the total of the side, back and front wall areas shall be and remain open and unrestricted

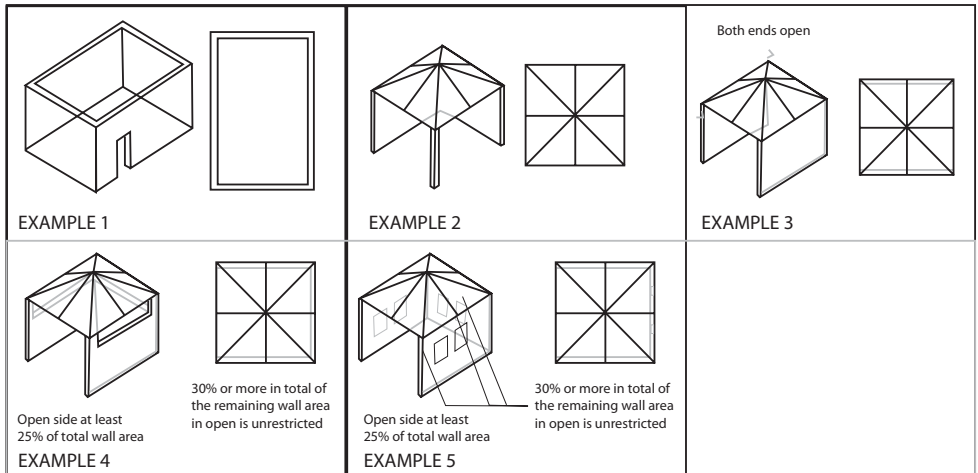

Installation

- Do not obstruct any ventilation ports on the body or the hood of the barbeque.
- The gas cylinder must be kept out of direct sunlight and away from any heat sources.
- During a gas cylinder swap or refill ensure that the control knob is in the **OFF** position and there are no naked flames in close proximity.
- Gas hose must NOT be twisted, kinked or under any form of tension. The gas hose should hang freely with no bends, folds or kinks.
- No part of the flexible hose should come into contact with any part of the barbeque that will become hot during operation.
- A regular inspection of the hose should be made to ensure that it is not cracking, breaking cutting or deteriorating in any other way.
- Any damage to the hose requires an immediate replacement from your local agent or gas expert.

Assembling your Barbeque

Start by unpacking the barbeque, and placing it on a flat surface. Be careful not to damage the painted finish.

Check that you have all the correct parts, barbeque, cooking grill, grease cup, Allen key, match holder, cylinder strap.

Remove all packaging materials and dispose of thoughtfully.

Before use, unhook the gas hose from the front right leg and from both back legs.

The gas hose should remain permanently hooked to the front left leg to keep it safely clear of the hot barbeque.

Only hook the hose back into place on all legs for transport once the barbeque has cooled!

How to Lock And Unlock the Hood & Cooking Grill:

The barbecue hood has a spring pin on each side that locks the hood and cooking grill in position. When both spring pins are pulled fully outwards from the barbecue, the pins can be rotated and rested back into the UNLOCKED  position. This allows the hood to freely open and close, and allows the cooking grill to be removed / inserted.



Also, when both spring pins are pulled fully outwards from the barbecue, the pins can be rotated and rested back into the LOCKED  position where the pins will be free to spring back into the barbecue.

Note that the hood can only be locked in the fully closed cooking position, or in the fully retracted transport position. In these positions, the hood and cooking grill will be fixed in place when the spring pin is LOCKED .

During cooking, you should always leave the spring pins in the UNLOCKED  position so you can freely open and close the hood.

Note that unless the grease cup is closed against the barbecue, the grease cup will deliberately limit the range of movement of the hood as detailed below.

How to Adjust the Grease Cup:

The barbecue has an adjustable grease cup that screws into the body of the barbecue from underneath. The grease cup should be adjusted to one of three positions:



(1) For transport, once the barbecue has cooled, the grease cup should be screwed up firm against the body of the barbecue to minimise leakage of any residual grease or moisture. You don't need to turn it very hard as it has a flexible o-ring that seals softly against the barbecue. In this position, the grease cup will allow the hood to swing to any position (when the spring pins are both unlocked).

 Before transport, ensure that the grease cup has been fully cooled, emptied, wiped clean and screwed firm against the barbecue to allow the hood to fully retract to the transport position.



(2) For cooking, when the barbecue is cool, the grease cup should be screwed away from the barbecue $3\frac{1}{2}$ full turns until the bottom of the grease cup is in line with the bottom of the two indicator tabs on the bottom of the barbecue. In this position, the grease cup will allow optimum airflow into the firebox for combustion, and also act as a stopper to hold the hood when opened in the ideal position as a windshield / splatter guard.



(3) For cleaning, once the barbecue has cooled, the grease cup can be easily unscrewed and removed completely from the barbecue for grease disposal and cleaning.

 ONLY ADJUST THE GREASE CUP POSITION WHEN THE WHOLE BARBEQUE HAS COOLED TO ROOM TEMPERATURE.

It is also good practice to only adjust the grease cup when the hood is fully closed and both spring pins are in the LOCKED POSITION  so the hood does not accidentally swing closed.

Gas Safety Checks

Before assembling your barbeque, you should ensure your barbeque is suited to the type of gas that you are going to use.

Universal LPG, Also Known As Propane:

Barbeques suited to Universal LPG should have a red printed label saying **“UNIVERSAL LPG”**. This is most commonly supplied as a portable 4 kg POL or 9 kg POL gas cylinder, which can be refilled or swapped at petrol stations or your place of purchase when empty. Either of these cylinders is suitable for use with the **“UNIVERSAL LPG”** version of this barbeque. Some homes have twin 45 kg LPG cylinders permanently installed near an outside wall. These cylinders supply LPG gas to many appliances in the home via copper pipes, and are filled as required by the gas supply company.

Natural Gas:

Barbeques suited to natural gas should have a black printed label saying **“NATURAL GAS”**. This is piped to your home in a similar fashion to water, so there are no cylinders to refill. You will need to contact your local gas company to determine if Natural Gas is available in your area.

To Change the Gas Type of Your Barbeque

If your barbeque is manufactured to operate from **“UNIVERSAL LPG”** (Propane/Butane mix), it can be connected to LPG (Propane) without any alteration. If you wish to connect that barbeque to natural gas, it must be converted beforehand using the appropriate conversion kit available at your nearest Barbeques Galore store.

If your barbeque is manufactured to operate from **“NATURAL GAS”** and you wish to connect to LPG, it must be converted beforehand using the appropriate conversion kit available at your nearest Barbeques Galore store.

Either conversion must be done by a licensed gas fitter or an authorised gas appliance technician. It is extremely dangerous to use the barbeque with the wrong type of gas. Fire or explosion may result. Conduct a leak test before use.

For Portable LPG Cylinder Use:

- For stand or cart models, do not attempt to connect to a gas cylinder before the BBQ is secured properly into its stand or cart.
- Ensure that the model you have is labelled **“UNIVERSAL LPG”** and therefore designed to run from an LPG cylinder.
- Check that the barbeque control knob is in the **OFF** position before any attempt is made to connect the regulator to the gas cylinder.

BARBEQUE
CONNECTION TO
HOSE REGULATOR

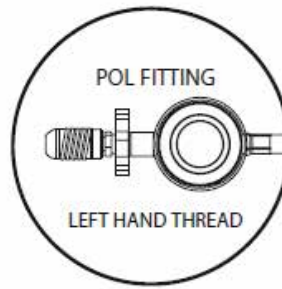
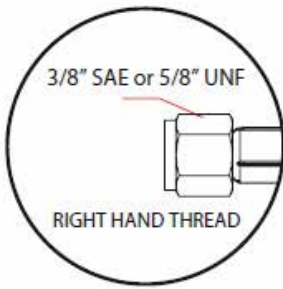

GAS BOTTLE
CONNECTION TO
HOSE REGULATOR

- Double check that the gas cylinder valve is securely in the **OFF** position before attempting to connect the regulator to the gas cylinder.
- If using without a cart, lock the strap provided to the gas cylinder handle and hook the eyelet at the other end of the strap to the hook on the back rear left leg of the barbeque. This is to prevent the hose from being able to be over stretched.
- For portable stand models, loop the strap provided around both left legs of the stand, through the cylinder handle and lock the strap to itself. This is to prevent the hose from being able to be over stretched.
- For cart models hook the LPG cylinder onto the left side of the cart, so that it hangs vertically and rests on the bottom hook. Adjust the top hook height if necessary, using the Allen key provided with the barbeque so that both the top hook and bottom hook are holding the cylinder in position, so the cylinder cannot swing.
- Check the hose that came attached to the barbeque, make sure that it has a rubber seal on the regulator end of it, and connect this end of the hose to the gas cylinder. You won't need a spanner here. Just turn the fitting in an **anti-clockwise** direction and hand tighten as much as you can. This should seal it sufficiently.
- The regulator as supplied should be firmly tightened but care must be taken not to over-tighten the connections. The regulator as supplied is the correct regulator for this item.
- Ensure the gas cylinder remains upright at all times.
- Should there be any concern in making the correct regulator connection please contact the after sales support help line towards the back of this manual.



For Permanently Installed LPG Supply or Natural Gas Use:

Barbeques which are connected to twin 45 kg LPG cylinders or to Natural Gas must be installed by a licensed gasfitter, in accordance with the requirements of AS 5601, and local gas authority requirements.

There are two approaches to installation:

Permanent Piped Connection: Your barbeque may be permanently connected to the main gas lines or LPG cylinders via copper pipe. This must be done entirely by the gasfitter, in accordance with requirements of AS 5601, and local gas authority requirements.

Your gasfitter will ensure that your barbeque is permanently connected to the supply via copper pipe, the gas pressure in the lines is adequate, pipe sizes are correct, all connections are secure, and that all necessary components (such as secondary regulators and manual shut offs) are included where regulations require them. Once this is done, the barbeque cannot be moved. It is a permanent fixture of the property.

Bayonet Point: Alternatively, you can have the gas fitter terminate the gas line using a "bayonet point". This allows you to connect and disconnect the barbeque using a special hose and bayonet termination. Such a hose is provided for the Natural Gas versions of this barbeque. For LPG installations, an appropriate hose is available through good barbeque retailers.

Even if your barbeque area already has a bayonet point, you will still need to call upon a gas fitter to ensure gas pressure is sufficient for your barbeque, and to ensure your barbeque functions correctly before leaving. Where a gas fitter is required, the gasfitter must test the safety and operation of the appliance before leaving, including gas pressure, ignition and burner operation. **Conduct a leak test before use.**

- For stand or cart models do not attempt to connect to the gas supply before the BBQ is secured properly into its stand or cart.
- If connecting to a Natural Gas supply, ensure that the model you have is labelled "**NATURAL GAS**" and therefore designed to run from Natural Gas.
- If connecting to an LPG supply, ensure that the model you have is labelled "**UNIVERSAL LPG**" and therefore is designed to run from LPG.
- Check that all the control knobs (including side burner) are in the **OFF** position before any attempt is made to connect the hose to the gas supply.
- Lock the strap provided to a strong point at the bayonet connection point and hook the eyelet at the other end of the strap to the hook on the rear left leg of the barbeque. This is to prevent the hose from being able to be over-stretched.
- Take the bayonet hose that was already fitted to the barbeque by an authorised person, and connect to the bayonet outlet.
- Should there be any concern in making the correct connection, please contact your local Barbeques Galore store.

To the installer: You must instruct the consumer on safe operation, and ensure these instructions are left with the consumer before leaving the site.

Leak Testing

Naked flames (matches or other open flames) must not be used to check for leaks. This is a dangerous practice which must be avoided.

IF YOU SMELL GAS!

- Immediately isolate the gas supply by turning the gas off at the bottle.
- Extinguish all naked flames.
- Do not operate any electrical devices close to the barbeque.
- Check for leaks as described below.
- Ensure that local area is well ventilated to remove any excess gas.
- If the gas smell continues the barbeque should not be operated under any circumstances and it is important to immediately turn off gas supply and contact the after sales support provider help line mentioned towards the back of this manual.
- ***Before proceeding, it is important that you leak test the barbeque. Make sure the barbeque control knob is OFF.***

Leak Tests Must be Carried Out in a Well Ventilated Area!

If you have a portable gas cylinder, turn the cylinder ON by rotating the knob anti-clockwise. If you have a wall connection, ensure the bayonet fitting is connected and supply valve open. Spray or pour soapy water (about the same concentration as washing up water) along the gas line including:

- The gas connection at the inlet of the barbeque, hose connections and regulator connections.
- The gas hose or copper piping, including any joints, valve connections or bends in the piping, and the gas connection at the gas cylinder or the wall connection.
- If bubbles appear, there is a gas leak.
- If the leak is at a connection, check and retighten all gas connections and joints and retest. If the leak is anywhere else, or if you cannot resolve the leak, do not proceed. Immediately turn the gas supply **OFF** at the source and contact your local Barbeques Galore store. If you have a bayonet connection, turn the supply valve **OFF**, remove the hose from the wall or floor fitting and contact your local Barbeques Galore store.

You can also check for leaks using a Gas Safety Gauge, available at your Barbeques Galore store. This provides an easier and more convenient way to check for leaks.

- After performing the soapy water test, please ensure the fittings are rinsed thoroughly with clean water.

It is Recommended that a Leak Test be Carried Out on an Annual Basis. Check Cylinder Connection Every Time you Refill or Exchange Cylinders.

Lighting your Barbeque

Before using the barbeque please ensure that you have fully read and understood the *IMPORTANT HEALTH & SAFETY INFORMATION* section at the front of this manual.

STARTING THE BARBEQUE:

Lighting the barbeque is easy, but must be done with due care.

- Ensure that all the controls are in the **OFF** position prior to initiating the start up process.
- Ensure that the grease cup is in the cooking position (unscrewed 3 ½ full turns from the barbeque – so that the bottom of the fat cup is in line with the two indicator tabs at the bottom of the barbeque).
- Make sure that the gas is turned on at the cylinder, or supply valve to the barbeque.
- Ensure that the hood is in the cooking (half open) position (not closed and not retracted for transport).
- Make sure there are no obstructions of airflow to the gas unit. Spiders and insects can nest within and clog the burner/venture tube at the orifice. A clogged burner tube can lead to a fire beneath the appliance.



Flame Thrower Ignition: This ignition system works by throwing a flame to the side of the burner to light it. Push the knob **IN** and turn anticlockwise to the **HIGH** position. Hold the knob **IN** until the burner ignites. You may need to push **IN** and turn the knob several times before ignition.

Manual Ignition: You can light your barbeque manually by using the match holder provided to hold a lighted match next to the burner, then push the knob **IN** and turn the burner control knob to **HIGH**. You can access the burner through the cooking grills or through the front holes in the optional hotplate.

If the burner doesn't light first go, push the knob **IN**, return the knob to the **OFF** position and try a couple more times. If the burner still does not light, wait a few minutes to allow the gas to disperse before trying again. If satisfactory operation cannot be achieved check the troubleshooting guide towards the back of this manual. Otherwise, consult your retailer before proceeding.

Note carefully: Failure to follow the lighting procedures correctly can lead to a hazardous condition.

Checking the Flames

The barbeque control knob has three basic positions: **OFF**, **HIGH** and **LOW**. You can achieve any flame height between **LOW** and **HIGH** by rotating the control knob between these positions.

Controlling the Flames

Look into the barbeque so that you can see the flames. They should be a soft blue colour with small yellow tips. Check with your retailer if in any doubt about the flames. Special note: "Blowback" is a situation where the flame burns inside the burner, towards the front. It can be recognised by a sharp roaring sound coming from the burner. It is not dangerous unless it is allowed to persist. If this occurs, simply push the knob **IN**, turn the burner **OFF**, wait a few seconds, then relight.

Turning Off (Shut Down)

When you've finished cooking, leave the burner controls on **HIGH** for a maximum of 5 minutes to burn off excess grease from the burner and other surfaces. To turn the barbeque off, it is best to turn **OFF** at the supply valve first, and allow all the gas left in the hose to burn off. This will only take a couple of seconds. Then push the knob **IN** and turn the burner control knob clockwise to **OFF**.

Note that failure to follow these shutdown procedures correctly can lead to a hazardous condition.

It's recommended for good hygiene and safety to empty and clean the grease tray at the end of each cooking session.

First Time Use

Preparing To Cook

- Wash the grill (and any optional hotplates) thoroughly in warm soapy water before first use. Dry thoroughly and then coat the top surface to prevent food sticking with canola oil or Nice & Easy which is salt free and available from your local Barbeques Galore store. Light the barbeque as described earlier and leave on **HIGH** for about 3 minutes to warm the barbeque up. Once the barbeque is warmed up, you should set the burners to your desired cooking temperature. You're now ready to start cooking up a feast. For ongoing protection of the cooking surface, follow the procedures in the Maintenance and Storing sections.

Cooking Hints

Controlling Flare Up

Flare-ups are caused by juices and oils from the food igniting in sudden bursts of flame that come up over the grill. A little bit of flare up as well as the resulting smoke is a good thing. It's what gives barbequed food that unique outdoor flavour. But if it happens too often, or if the flame lasts more than a few seconds, your food will char, so you need to control it:

- First of all, cooking very fatty foods may cause a lot of flare up. You should trim excess fat off your meat.
- Excess flaring usually means the burner control is up too high, turning it down before flare-up occurs will usually prevent it happening in the first place.
- Moving the meat away from the flare up will also reduce the problem.
- Some very fatty foods are best cooked on the optional hotplate or in a baking dish to collect the fat and shield the food from direct heat. Always remember to switch the barbeque **OFF** once you are finished cooking.

Keeping Your Food Moist

It's easy to keep your food moist and succulent on a barbeque by following these guidelines:

- Use tongs instead of a fork when turning meat and poultry. A fork pierces the flesh and causes the juice to seep out.
- Juices tend to rise to the top of a piece of meat and then settle. Each time you turn the meat over, the juices are lost. It's better to quickly sear the meat on each side (about half a minute) then leave the meat to cook on one side at a time, turning once only before serving. (An alternative method is to turn the meat every 30 seconds or so, before the juices have time to reach the top surface. This keeps the meat succulent and juicy, but means constant adjusting while cooking.)
- Baste food with light marinade or oil a couple of times while cooking, though watch out for excessive flare-up if too much oil is used.
- Using the roasting hood as outlined later in these instructions is an excellent way to preserve moisture and succulence and takes the hard work out of barbeque cooking.

Other Useful Tips

You don't need to be an expert to serve up a tasty, good looking meal. Try these ideas:

- Although cooking on the optional hotplate seems easier, cooking on the grill gives you a more authentic barbeque flavour. Natural juices vapourise, with the vapours penetrating back into the food.
- As an alternative to simply grilling, try marinating your meat, fish, poultry or vegetables first. The longer you leave the food to stand in the marinade, the more thoroughly the flavour will soak through. Several pre-made marinades are available and good recipes are easy to come by. It is best to leave food standing in the refrigerator.
- If you use a tomato or sugar based sauce for basting, apply it in the last 5-10 minutes of cooking. Using these sauces over a longer period of time will result in over-browning.
- To prevent meat from curling, slash the remaining fat at roughly 5cm intervals, taking care not to cut into the meat.
- Avoid burning or charring food as this has been shown to be unhealthy. Don't leave cooked food standing for too long before eating.

Covered Cooking

Cooking with the Hood Closed

Using the roasting hood traps heat, moisture and flavour that is normally lost on an open top barbeque. The Ziegler and Brown Grill is designed with plenty of power to heat up quickly and cook lots of food with the hood either open or closed. With the hood closed and the barbeque already pre-heated, its important to then turn burners to **LOW** and occasionally even **OFF** as required, in order to not overheat the barbeque which could result in increased temperature hazards and burning your food. Never let the hood temperature exceed 300 °C.

For covered cooking, there are two basic ways to cook:

(A) Direct Cooking and (B) Indirect Cooking

(A) Covered Cooking-Direct Cooking Method

This is when you place the food directly over the lit burners, either on the grill or the optional hotplate.

This method is great for frying, searing and grilling, especially with thinner cuts and foods that require shorter cooking time. Cooking takes less time than with the hood open, and the results are more tender and juicy. Preheat the barbeque with both the burner on **HIGH** and the hood closed until the hood thermometer reads around 200°C. Importantly, once the barbeque is pre-heated and the hood is closed, heat is trapped around the food, so the

burner will usually only need to be on **LOW** and in some rare cases, **OFF** for short periods. Heat from the lit burner will circulate all through the hood cooking quite evenly. Quite close attention needs to be paid to the food, and the burners frequently reset to **LOW** or occasionally **OFF** as required to prevent overheating.

Don't be afraid to open the hood often to check progress. You are in full control of the temperature by turning the burner higher, lower or occasionally **OFF** as required. The gas burner will respond instantly and powerfully to your control. Most importantly, use the hood thermometer as a warning guide that the barbeque is too hot. For grilling most foods, aim to keep the thermometer below around 200°C. Never let the temperature on the thermometer reach over 300°C or the barbeque may overheat and burn your food. A separate probe thermometer is available as an accessory from all Barbeques Galore stores. This takes the guesswork out of knowing when your food is cooked.

Always remember to switch the barbeque OFF once you are finished cooking.

(B) Covered Cooking-Indirect Cooking Method

This is when you shield the food from direct heat by using an optional drip pan and roasting rack or any other method of shielding the food from direct heat such as aluminium foil under a roasting rack, or a pizza stone. The burner is adjusted from mostly **LOW** to **HIGH** and occasionally **OFF** for short periods to maintain constant lower roasting temperatures. This method is ideal for thicker cuts of meat, legs of lamb, pork, shoulders of beef, whole chickens and whole fish.

Moist, hot air rises from the lit burners and circulates around the food, trapping juices and flavour. Even cakes and breads can be cooked in your barbeque this way. Cooking lower and slower lets the food cook completely through without burning on the outside, yet remaining juicy and tender on the inside.

Preheat the barbeque with the burner on **HIGH** and the hood closed for 5 minutes or until the hood thermometer reads around 200°C. Best results are achieved by placing your roast in a rack and that rack in a drip pan. The roast is slightly elevated to allow heat to circulate all the way around, and water, wine, juices, herbs can be added to the drip pan to help flavour the roast and make a baste or gravy. Use a large drip pan positioned centrally in the barbeque. Importantly, once the barbeque is pre-heated and the hood is closed, heat is trapped around the food, so the burner that is on will mostly only need to be on **LOW** and sometimes turned **OFF** for short periods. Heat from the lit burner will circulate all through the hood cooking quite evenly.

TIP: Maintaining a level of liquid (water, juice, wine) in the drip pan keeps the roast moister and lowers the roasting temperature.

Importantly, use the hood thermometer as a warning guide that the barbeque is too hot. For roasting most foods, aim to keep the thermometer around 200°C to avoid burning.

For short periods of browning only, or for 10 minutes to make pork crackling, aim for around 250°C.

For smokey roasting, lower temperatures and longer cooking times will result in more intense smoke flavour and more tender meats. Aim for around 175°C. A tray of water positioned on the grill will help keep the temperature stable and lower.

Always use a probe thermometer to ensure that the meat has cooked all the way through to the right temperature. Don't ever let the temperature exceed 300°C on the hood thermometer or the barbeque may overheat. A separate probe thermometer is available as an accessory from all Barbeques Galore stores. This takes the guesswork out of knowing when your food is cooked.

Always remember to switch the barbeque OFF once you are finished cooking.

Barbeque Tip

Great chefs will tell you that cooked meats need to "rest" away from the heat of the barbeque before slicing for several minutes to allow the moisture pushed to the surface to redistribute. If you don't rest the meat, moisture that has pooled near the surface will run out and the rest of the meat will be quite dry. Covering the meat in aluminium foil while its resting helps keep it from cooling too fast.

Use the few minutes while resting the meat to open the barbeque hood, turn the burner to **HIGH** for 3 to 5 minutes to burn off food residue. After 5 minutes, turn the barbeque **OFF**. While the cooking surfaces are still hot, take a long moistened handled brush or scraper and remove remaining oil and food residue. You should use an oven mitt to avoid burns. 5 minutes now will save 30 minutes next barbeque.

Always remember to switch the barbeque OFF once you are finished cooking.

Internal Meat Temperatures

Beef

Meat Probe temperatures:

Rare 140°F / 60°C. Medium 150°F / 66°C. Well-done 170°F / 77°C

Lamb

Meat Probe temperatures:

Rare 140°F / 60°C. Medium 150°F / 65°C. Well-done 165°F / 75°C

Veal

Meat Probe temperatures:

Rare not advised. Medium 155°F / 70°C minimum safe temperature. Well-done 165°F / 75°C

Pork

Meat Probe temperatures:

Rare not advised. Medium 150°F / 65°C minimum safe temperature. Well-done 160°F / 70°C

Poultry

Meat Probe temperatures:

Rare not advised. Medium 170-175°F / 75-80°C minimum safe temperature.

Well Done not advised; poultry tends to dry out over 175°F / 80°C

To obtain correct temperature use an instant-read meat thermometer in the thickest part of the flesh, careful not to touch any bone.

Cooking Times

Poultry

Cut of Meat	Weight or Thickness	BBQ Method	Approx Cook Time
Chicken (whole)	2 kg	Indirect	70-80 min
Chicken (halved or quartered)	2 kg total	Indirect	55-65 min
Chicken (breasts, boneless)	150 g ea	Direct	12-15 min
Chicken (breasts, boneless)	150 g ea	Indirect	23-25 min
Wings	120 g	Direct	23-30 min
Wings	120 g	Indirect	35-40min
Cut Up Legs and Wings	2 kg	Direct	10 min
Cut Up Legs and Wings	2 kg	Indirect	40 min
Boneless Cubes (For Kebabs)	2.5 cm	Direct	12-15 min total
Turkey (Whole)	4.5 kg	Indirect	2-3 hours

Beef

Cut of Meat	Weight or Thickness	BBQ Method	Approx Cook Time
Roasts	2 kg	Indirect	50 min per kg (rare)
Steaks (T-bone, New York, Porterhouse, Round, Sirloin)	2.5 cm	Direct	5-6 min per side (rare)
Rump Steak	3.5 cm	Direct	5-7 min per side (med rare)
Minute Steaks	0.5 cm	Direct	1.5-2 min per side (rare)
Ground Beef Patties	2.5 cm	Direct	4-5 min per side (rare)
Ground Beef Patties	2.5 cm	Direct	5-6 min per side (med. rare)
Ground Beef Patties	2.5 cm	Direct	6-7 min per side (well done)

Thermometer Temperature: Rare = 60°C, Medium = 66°C, Well-done = 77°C

Seafood

Cut of Meat	Weight or Thickness	BBQ Method	Approx Cook Time
Whole Fish (with or without head and tail)	2 kg	Indirect	30-35 min total
Steaks & Fillets	2 cm	Direct	3-4 min per side
Prawns	Medium sized	Direct	1.5-2 min per side
Lobster Tails	300 g	Direct	9-13 min

Fish is done when flakes easily when prodded with a fork or knife in the thickest part. Frozen fillets should not be thawed before cooking. Cooking times will be approximately double that of fresh fish.

Maintenance - Cleaning Your Barbeque

Your barbeque will look better and last longer if you keep it clean. Follow these simple steps:

- Throwing cold water over any hot surface of the barbeque is NOT recommended and is potentially dangerous.
- Avoid handling and touching hot parts of the barbeque.

The Cast Iron Cooking Surface on the Grill and Optional Cast Iron Full Hotplate:

Once cooking is finished a burn-off process to clean the barbeque should be as follows:

- Remove all excess burnt food with a long handled scraper or brush.
- Light the burner, set to the **HIGH** position and leave running with the hood fully open for approximately 5 minutes.
- During this 5 minute period most excess food, fat and juices should be burnt off making cleaning easier.
- The roasting hood must be left in the open position during the burn off period.
- Turn the barbeque **OFF** at the control knobs and at the gas supply valve.
- Using Bar-B-Chef Heavy Duty Cleaner and warm water, scrub the cooking surfaces with a long handled brush or scourer. Rinse thoroughly with fresh warm water.
- Once dry, store barbeque with the hood closed and out of the elements and direct sunlight.

The Non-Stick Cooking Surface on the Optional Aluminium Half Hotplates:

- Wipe the surface clean with a damp paper towel.
- For more stubborn baked on grease, first soak the hotplate in water with some dishwashing detergent.
- Rinse thoroughly with fresh warm water

The Burners:

- Occasionally the burner holes may get slightly clogged with grease and food particles. Leaving the burner on **HIGH** for a maximum of 5 minutes with the hood open after you've finished cooking will remove most of this.
- Check the burner periodically for more persistent blockages. In particular, you should ensure that the aeration vents are free of insect nests and spider webs.
- To clean the burner, once **OFF**, let it cool down and inspect. If any of the holes are clogged, use a toothpick to unclog the holes.
- If the burner accidentally gets too wet, it will not operate properly until thoroughly cleaned and dried.

The Barbeque Firebox and Hood:

- Regular care and maintenance of the barbeque firebox and hood will significantly increase its life and long term appearance.
- Excess grease and fat can be removed using Bar-B-Chef Heavy Duty BBQ Cleaner and warm water with a soft scraper (not metal edged). Do not use caustic cleaning agents as these can quickly damage surface coatings and gradually damage even metal finishes.

- Before cleaning the inside of the body it is advisable to cool, then remove the cooking surface and be careful not to get water into the burner holes.
- Care must be taken not to immerse the gas controls (manifold and injectors) in water.
- After cleaning and re-assembling the barbeque it is important to check that the barbeque functions correctly.

The Grease Cup:

You should clean the grease cup itself after every use to prevent a build up of grease. If you don't do this, a fat fire can result. This can be quite dangerous, and any consequential damage to your barbeque will not be warranted.

Other Surfaces:

- Once BBQ has cooled, wipe down as required with warm soapy water.

Storing your Barbeque

Your barbeque is designed to be used outdoors. However, just like a car, you will prolong the life of the appliance if you store it out of direct exposure to the elements when not in use. Ideally:

- Place a waterproof cover over it or store in a carry bag. These are available from all Barbeques Galore stores.
- Where possible, move the barbeque to a covered location. If you are storing it in a closed room (e.g. a shed or a garage) you should keep the cylinder away from any other cylinders or any cars, boats, motorcycles or any other petrol engines.
- If the barbeque is not likely to be used for some time, clean it thoroughly. Spray the grease cup thread with a little vegetable oil to ensure it's lubricated ready for use next barbeque.

Servicing your Barbeque

Apart from cleaning, your barbeque is a fairly low maintenance item. A couple of things are worth looking at though. Remember to turn **OFF**, cool the BBQ down and disconnect the gas before any maintenance is carried out.

- If there are any signs of wear or cracking in the barbeque hose, you will need to replace it immediately. Ensure you replace it with a hose and regulator purchased from Barbeques Galore to ensure proper gas connection compatibility. Connect the nut of the hose to the gas inlet on the right side of the barbeque. You **MUST** use a spanner to tighten it properly, and a second spanner to hold the manifold firmly while you tighten the hose. Do not use sealing tape. The connection is designed to seal properly without it. Perform a leak test as explained in the installation section before using.
- If your barbeque uses a flexible hose to connect to the gas, check the rubber O-ring on the regulator end of the hose assembly after every cylinder refill/exchange at least once a year. If it appears worn or cracked, have it replaced.

- We recommend having your barbeque checked by an authorised service agent every 5 years. This is to ensure there are no leaks and that all components are still functioning correctly.
- If you use a portable LPG gas cylinder, you will need to have the cylinder serviced or replaced every ten years. The date of the last service should be stamped on the neck of the bottle.
- Occasionally you will need to remove your burner for cleaning or adjustment. To remove the burner, remove the two screws holding it in place, then pull the open end of the burner away from the gas jet at the front of the barbeque. Reverse this procedure to reinstall the burner making sure the burner venturi fits properly over the gas injector.

As you can see, it's easy to keep your barbeque in great shape so it can give you years of trouble free enjoyment.

TROUBLE SHOOTING

Problem	Possible Cause	Prevention / Cure
Burner will not light	No gas flow Obstruction of gas flow Burner is off the valve Spider webs in venturi Burner ports blocked	Check cylinder contents and refill Clear burner tubes Check for bent or kinked hose Re-engage burner onto the valve. Clean venturi Clean burner ports
Sudden drop in gas flow or reduced flame height	Cylinder out of gas.	Check cylinder contents and refill
Irregular flame pattern, flame does not run the full length of burner	Burner ports are blocked	Clean burner ports
Flame yellow or orange	Burner may have residue Spider webs in venturi Food residue or grease on burner Burner is off the valve Salt in food / marinade Grease cup not in cooking position	Burn on HIGH for 5 minutes with lid open. Clean venturi Clean burner Re-engage burner onto the valve No need to be concerned Screw grease cup 3 ½ full turns out from bbq
Flame blow out in high or gusting winds	Turn front of BBQ to face wind Low on gas	Turn front of barbeque into the wind. Check cylinder contents and refill
Flare-up	Grease build up Excessive fat in meat High cooking temperature	Clean grill and barbeque body Trim fat from meat before grilling Lower temperature accordingly
Persistent grease fire	Grease trapped by food build-up around burner system	Do not apply water. Turn knob to OFF . Turn gas OFF at cylinder. Leave hood in closed position and let fire burn out. After grill cools, remove and clean all parts
Persistent flashback	Burner and/or burner tube is blocked burner tube.	Turn knob to OFF . Clean and fully dry burner and/or burner tube. Relight

TROUBLE SHOOTING

Problem	Possible Cause	Prevention / Cure
Inside of lid appears to be peeling- like paint peeling	Baked on grease build-up	Clean thoroughly
Hood will not open	Spring pins are in locked position	Adjust spring pins to unlock position
Hood will not swing to retracted transport position	Grease cup is in cooking position	Screw grease cup firm against bbq

OPTIONAL ACCESSORIES:

Full Size Cast Iron Hotplate (code ZG1GHPFULL):

Use this to replace the standard cooking grill. Great for really fatty foods or eggs, pancakes, or smaller sized foods that could fall through the grill.

Half Aluminium Reversible Hotplate / Griddle (code ZG1GHPHALF):

These can be purchased and used as cast iron singles or two at a time. Lightweight with a non-stick coating, they are easy to carry and easy to clean. They can sit on top of the existing grill or buy 2 pieces to replace your existing grill. An optional carry lock (code ZG1GHPLOCK) holds two pieces in place in the barbeque instead of the regular grill or hotplate for ultra lightweight travel.

Portable Stand (code ZG1GSTAND):

This lightweight, compact, quick assembly stand sturdily and safely supports your barbeque. The aluminium construction eliminates any rust concerns so it will last for years to come. Supplied in its own carry bag for easy transport and storage.

Cart Upgrade Kit (code ZG1GCARTUPK):

Converts your portable stand into a mobile cart with detachable side shelves, a handy front condiment shelf, lockable castor wheels, adjustable cylinder hook and a sturdy bottom storage shelf.

Carry Bag (code ZG1GBAG):

Safely pack, store and carry and transport your barbeque plus any additional FULL and HALF hotplates.

Large Cover (code: ZG1GCVRLGE):

Fits comfortably over barbeque and stand with hood closed to protect from the elements. Vented to allow air circulation.

Small Cover (code: ZG1GCVRSML):

Fits comfortably over barbeque alone with hood closed to protect from the elements. Vented to allow air circulation

Recipes

Anything you can cook in your oven you can do on a barbeque: roasts, breads, casseroles, pizzas, lasagne, are just a few of the possibilities. Here are some simple recipes to get you started.

Breakfast of Champions

Serves 2

Cooking Time 10 - 15 minutes

Accessories:

Ziegler and Brown Half Hotplate to suit

Portable Grill



Ingredients

- 4 eggs
- 4 slices of bacon
- 2 or 3 large mushrooms
- 6 breakfast sausages
- 3 tomatoes, halved
- Oil
- Salt and pepper

Preparation

1. Place a Ziegler & Brown half hotplate into the BBQ, smooth side up. Preheat your BBQ burner, on **HIGH**, hood closed until the temperature reaches 200°C. Open the hood turn burner down to **LOW**.
2. Place the bacon on the hotplate and the sausages on the grill, keep turning as required.
3. After 6 minutes place the tomatoes and mushrooms on the grill for a further 4 minutes.
4. After another 4 minutes turn the tomatoes and mushrooms over, lightly oil the hotplate, add the eggs and cook to your liking.

Always remember to switch the barbeque OFF once you are finished cooking.

Mates Steak

with a Garlic Butter sauce

Serves 4

Cooking Time 10 - 20 minutes



Ingredients

- 4 rump steaks (1.5 - 2 inch thick)
- Salt
- Cracked pepper
- Olive oil
- 2 cloves garlic - finely chopped
- 200g unsalted butter
- ½ teaspoon Worcestershire sauce
- 1 tablespoon chopped parsley

Preparation

1. Preheat BBQ, burner on **HIGH**, hood closed until temperature reaches 250°C.
2. Oil both sides of the steaks with and sprinkle salt and pepper on one side.
3. Place the steaks spiced side down onto the open grill for 3 to 4 minutes. Cook with the hood open, burner on **HIGH**.
4. Salt and pepper the other side of the steaks. Flip steaks over and repeat grilling for 2 to 3 minutes on **HIGH**.
5. Check the steaks by pressing gently with the back of your tongs. Rare steaks will spring back quickly. Medium steaks will spring back slowly. Medium well-done and well-done steaks will not spring back.
6. Once cooked to your liking, cover steaks loosely with foil to rest for 5 minutes.

Garlic Butter Sauce

1. Put the butter in a bowl and leave at room temperature until it is soft enough to work. Add the garlic, Worcestershire sauce, parsley and mix to combine thoroughly. Add salt and pepper to taste.
3. Refrigerate until firm. When ready to use, remove wrap and slice into rounds. Place on hot steak just before serving.

2. Using a spatula scrap the butter mixture on to a square of plastic wrap. Shape into a log and roll the mixture up in the plastic, twisting the ends.

TIP: Once rested place the steak back on the grill on **HIGH** for 20 seconds on each side if you like your steak served hot.

Ziegler Kebabs

Serves 2

Cooking Time 15 - 20 minutes

Accessories:

Ziegler and Brown Flexible Skewers



Ingredients

- 10 lamb chunks
- Salt and pepper
- Olive oil
- Assortment of vegetables your choice: corn, chillies, capsicum, zucchini, baby squash, mushrooms.

Preparation

1. Preheat your BBQ using burner on **HIGH** and the hood closed, to 200°C.
2. Using the Ziegler & Brown Flexible Skewers organise the lamb and vegetables so that the pieces are scattered.
3. Lightly brush with olive oil and season with salt and pepper to taste.
4. Open the hood, turn both burner down to **LOW**, cook the kebabs, turning as required for 15 minutes or until the lamb is cooked to your liking.

Always remember to switch the barbeque OFF once you are finished cooking.

Spring Snapper

Serves 4

Cooking Time 30 - 45 minutes



Ingredients

- 1 whole snapper (scaled and gutted)
- 300ml sour cream
- 1 lemon zested and juiced
- 2 lemons sliced
- ½ bunch fresh dill
- 3-4 spring onions
- Capsicum
- Parsley for presentation

Preparation

1. Preheat your BBQ with burner on **HIGH** and the hood closed to 200°C. Turn both burner to **LOW**.
2. Combine sour cream, lemon zest, lemon juice and chopped dill into a bowl. Add salt and pepper to taste.
3. Spread the mixture generously inside the fish.
4. Place one banana leaf or foil on the bottom of barbeque. Spread some of the lemon slices onto the leaf, the rest into the cavity, then the snapper on top. Place half the parsley on top of the fish.
5. The banana leaf and lemon shields the fish from direct heat.
6. Close the hood and cook for around 10 to 15 minutes.
7. Open the hood, cover the fish with the rest of the lemon slices and second banana leaf, and flip it over. Place the spring onion and capsicum on top. Close the hood, After 8 minutes, turn the barbeque **OFF** and let the residual heat cook the fish for another 10 to 15 minutes.

TIP: Fish will continue to cook whilst covered and resting. Take the fish out of the BBQ once you see it flaking.

Roast Beef Rack

Serves: 4

Cooking Time: 60 minutes

Accessories:

Ziegler & Brown Enamel Enamel Drip Tray

Ziegler & Brown Roast Holder

Bar-B-Chef Remote BBQ Thermometer



Ingredients

- 2kg or 4 boned beef rib rack
- 1/2 butternut pumpkin
- 2 jacket potatoes
- 1/2 sweet potato (yam)
- 3 spring onions
- 1 bunch of rosemary
- 1 bunch of sage
- 1 cup red wine
- 200ml beef stock
- Salt and pepper
- Olive oil

Preparation

1. Using burner on **HIGH** and the hood closed, preheat your BBQ to 250°C.
2. Rub the beef with salt and pepper and olive oil. Cover the beef with the picked herbs
3. Peel and halve the onions, halve the potatoes and cut the pumpkin into small pieces. Pour the beef stock and the red wine into the Enamel Tray.
4. Skewer the beef onto the Roast Rack, position the onions, potatoes and pumpkin around the beef and place into the hot BBQ at about 250°C.
5. Insert the Bar-B-Chef BBQ Remote Thermometer and set for beef (medium rare or however you prefer) close the hood and cook for 15 minutes, then turn to 200°C top up the liquid level in the drip tray and cook until the Bar-B-Chef Remote Thermometer tells you the desired temperature is reached.
6. Remove from the BBQ and cover with foil before serving

Always remember to switch the barbeque OFF once you are finished cooking.

Ziegler & Brown Barbeque Accessories



Other available accessories include:

Gas Safety Gauge: Award winning safety device. Shuts gas off fast and completely in case of a major leak, and helps you detect minor ones without worrying about soapy water.

Weather Cover: Protect your investment with a cover that fits neatly over your barbeque and protects it from the elements as well as backyard pests.

And there are many more. Ultimately, anything you can cook in the kitchen, you can cook on your barbeque.

G.L.G. Australia Pty Ltd (ACN 001 185 002)

Building A2, Campus Business Park, 350-374 Parramatta Road, Homebush NSW 2140

Ph: 02 9735 4111

More Information or Help?

Need more information or assistance in any way? You can call your nearest Barbeques Galore store where barbeque experts will be happy to help you. Just phone 1300 301 392 or visit our website at: www.barbequesgalore.com.au

For Warranty information, refer to the enclosed Warranty Card.

TECHNICAL SPECIFICATIONS

Models – **ZG1GK, ZG1GRK**

Gas Type – **UNIVERSAL LPG**

Burner Injector Size – **0.9mm**

Burner Gas Consumption – **10.8 MJ per hour**

Burner Gas Pressure – **2.75Kpa**

Total Gas Consumption – **10.8mj/hr**

Models – **ZG1GNGK, ZG1GRNGK**

Gas Type – **NATURAL GAS**

Burner Injector Size – **1.48mm**

Burner Gas Consumption – **10.8 MJ per hour**

Burner Gas Pressure – **1.0Kpa**

Total Gas Consumption – **10.8mj/hr**

IAPMO No GMK 10188

SPARE PARTS INCLUDING PARTS FOR OPTIONAL EXTRAS

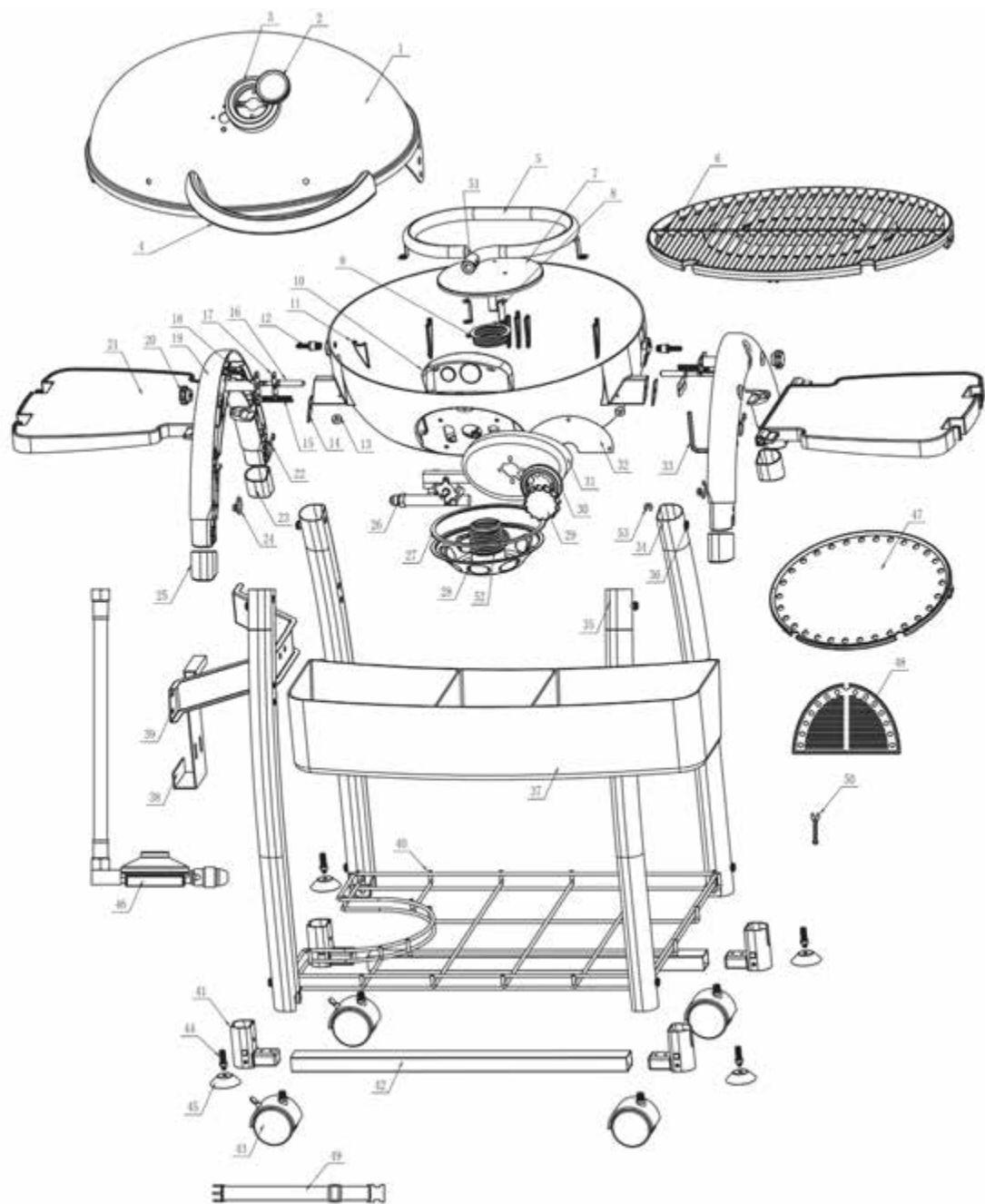

DIAGRAM #	GLG PARTS CODE	DESCRIPTION	QTY PER BBQ	QTY PER PARTS CODE
1	CP9142708	Hood (RED)	1	1
1	CP9142709	Hood (GREY)	1	1
2	CP9142710	Thermometer gauge	1	1
3	CP9142711	Thermometer BEZEL	1	1
4	CP9142712	Hood handle	1	1
12	CP9142713	Hood hinge	2	1
11	CP9142714	Firebox	1	1
31	CP9142715	Control panel RED	1	1
31	CP9142716	Control panel GREY	1	1
32	CP9142717	Control panel heat shield	1	1
10	CP9142718	Valve cover	1	1
30	CP9142719	Knob Bezel	1	1
29	CP9142720	Knob	1	1
26	CP9142721	Valve assembly	1	1
5 51	CP9142722	Burner assembly (with screws, nuts, bolts, washers, airflow adjustable sheet)	1 1	1 1
6	CP9142723	Cooking grill	1	1
28 52	CP9142724	Grease cup assembly	1 1	1 1
7 8	CP9142725	Grease cup shield assembly	1 3	1 3
9	CP9142726	Replaceable thread part (& screws, nuts, bolts etc)	1	1
27	CP9142727	Grease cup seal	1	1
20	CP9142728	Spring pin knob	2	1
19	CP9142729	BBQ leg	2	1
18	CP9142730	Spring pin housing	2	1
17	CP9142731	Spring pin guide	2	1
16 15	CP9142732	Spring pin with spring	2 2	1 sets
24	CP9142733	Hose ring	1	1
22	CP9142734	Hose hook	3	1

DIAGRAM #	GLG PARTS CODE	DESCRIPTION	QTY PER BBQ	QTY PER PARTS CODE
23	CP9142735	Back left & front right rubber foot B	2	1
25	CP9142736	Back right & front left rubber foot A	2	1
14	CP9142737	Insulation spacer	2	1
13	CP9142738	Hood rubber stopper	2	1
46	CP9142739	Regulator + hose Assembly	1	1
34	CP9142740	Back right & front left stand leg A (optional)	2	1
35	CP9142741	Back left & front right stand leg B (optional)	2	1
41	CP9142742	Corner piece of bottom brace (optional)	4	1
42	CP9142743	Bottom brace (optional)	2	1
45 44	CP9142744	Adjustable foot with thread shaft (optional)	4 4	1 set
36 53	CP9142745	Captive hex head bolt (optional)	8 8	1 sets
33	CP9142746	Allen Key	1	1
49	CP9142747	Strap	1	1
	CP9142748	Portable stand carry bag (optional)	1	1
21	CP9142749	Side shelf (optional)	2	1
37	CP9142750	Condiment shelf (optional)	1	1
40	CP9142751	Bottom basket (optional)	1	1
43 44	CP9142752	Castor Assembly (optional)	4	1 set
39	CP9142753	Cylinder hook support (optional)	1	1
38	CP9142754	Cylinder hook (optional)	1	1
	CP9142756	Bolt pack (spares)	1	1
	CP9142757	Bolt pack for Portable Stand (spares)	1	1
	CP9142758	Bolt pack for Cart Upgrade Kit (spares)	1	1
47	ZG1GHPFULL	Cast iron full hotplate (optional)	1	1
48	ZG1GHPHALF	Aluminium iron half hotplate (optional)	1 or 2	1

WARNING: For Storage and Cylinder exchange, disconnect hose at the cylinder only, do not disconnect hose from the appliance.

Minimum clearance from combustible surfaces:

Side of BBQ - **250mm**

Back of BBQ - **250mm**

Vertical above BBQ - **1500mm**

BARBEQUE DIMENSIONS (Hood Closed)

	WIDTH (mm)	DEPTH (mm)	HEIGHT (mm)
Barbeque only	673	456	416
Barbeque and Stand	673	569	1047
Barbeque and Cart	1140	662	1090

Air is admitted from hole at the bottom of the firebox and through the middle of the grease cup. When the hood is closed, air is also expelled out from the gap at the back of the barbeque between the hood and the firebox. Please ensure both these ventilation gaps remain unobstructed.

Manifold connection is 3/8" SAE at the lower left of the control panel.

WARNING: For Storage and Cylinder exchange, disconnect hose at the cylinder only, do not disconnect hose from the appliance.

**Ziegler
&Brown**

PORTABLE GRILL

THE TAKE ANYWHERE BBQ

